

## 11 Line Bored Lock



# Table of Contents

## 11 Line Bored Lock

Features, Benefits and Applications . . . . .	3	Cylinders . . . . .	11
Windstorm Certifications . . . . .	4	Mechanical and Cylinder Options . . . . .	12-13
STC 55 Acoustic Door Systems . . . . .	5	Cylinder Options . . . . .	14
Functions . . . . .	6-7	Tools . . . . .	15
Function Conversion Chart and Retrofit Options . . . . .	8	How to Order, Finishes, Packaging . . . . .	16
Lever and Rose Designs . . . . .	9	Architectural Specifications . . . . .	17
Latches and Strikes . . . . .	10		

### Specifications

For Doors	1-3/4" to 2" (44mm to 51mm) thick doors standard Specify 31- option for doors 2-1/4" to 2-1/2" (57mm x 64mm) centered in door prep, no paneling. Consult factory for other door thicknesses available by special application. Not available for 1-3/8" (35mm) thick doors
Backsets	2-3/4" (70mm) standard 3-3/4" (95mm) backset available (23- option) 5" (127mm) backset available (25- option)
Bearing Assembly	Cast and machined stainless steel
Front	Wrought brass, bronze or stainless steel 2-1/4" x 1-1/8" (57mm x 29mm) Self-adjusting for flat to 1/8" (3mm) in 2" (51mm) bevel
Strike	Wrought brass, bronze or stainless steel 800 curved lip strike standard 808 ANSI curved lip strike available (28- option) Wrought box strike available (WBS- option)
Hand	Universal, not handed
Levers	Secured with 6 lobe security set screw standard 6 Lobe tool packed with each lock
Roses	Heavy wrought brass, bronze or stainless steel
Latchbolt	Stainless steel bolt 7/8" (22mm) dia. x 1/2" (13mm) throw 3/4" (19mm) throw for pairs of doors (41- option)
Cylinder	Brass, 6-Pin, LA keyway standard
Keys	Two, nickel silver
Masterkeying	Can be masterkeyed or grand masterkeyed Construction key systems available
Finishes	03, 04, 09, 10, 10B, 10BE, 10BL, 14, 15, 20D, 26, 26D, BSP, WSP
Door Prep	ANSI/BHMA A156.115 (161)
Minimum Stile	4-1/4" (108mm) with B and O roses 4-1/2" (114mm) with E and L roses

### Certification Compliance

ANSI/BHMA	Meets and greatly exceeds ANSI/BHMA A156.2 Series 4000 - Grade 1
UL-cUL	UL and cUL listed to Canadian safety standards Listed for 3 Hour Doors (double doors require 41- option)
Positive Pressure	Meets ANSI/UL 10C, Positive Pressure Fire Test of Door Assemblies
ADA	All levers conform to ADA requirements for barrier-free accessibility. Levers (L, J and P) conform to California Administrative Code Title 19
Windstorm Certifications	UL Listed: ANSI/SDI-BHMA A250.13; ANSI/ASTM E330-2002; ANSI/ASTM E1886-2005 & ASTM E1996-2009 UL Certification Directory ZHEM.R21744 Latching Hardware Listed on Florida Building Code Website: FL4351-R1

Any retrofit or other field modification to a fire rated opening can potentially impact the fire rating of the opening, and Sargent Manufacturing Company makes no representations or warranties concerning what such impact may be in any specific situation. When retrofitting any portion of an existing fire rated opening, or specifying and installing a new fire-rated opening, please consult with a code specialist or local code official (Authority Having Jurisdiction) to ensure compliance with all applicable codes and ratings.

Copyright © 2007-2020, SARGENT Manufacturing Company. All rights reserved. Reproduction in whole or in part without the express written permission of SARGENT Manufacturing Company is prohibited. Patent pending and/or patent www.assaabloyds.com/patents.



#### MicroShield®

As part of their promise to provide innovative solutions to their customers, certain ASSA ABLOY Group brands offer the MicroShield® technology, a silver-based antimicrobial coating designed to inhibit the growth of bacteria.

MicroShield® is a registered trademark of Yale Security Inc., an ASSA ABLOY Group company.

#### MicroShield® Coating

- Revolutionary finish coating available on all SARGENT product lines, utilizes a silver-based antimicrobial compound from Agion Technologies
- As an integral part of the finish coating, MicroShield® lasts for the life of the hardware
- MicroShield® coating permanently suppresses the growth of bacteria, algae, fungus, mold and mildew. It is effective against a broad spectrum of bacteria.
- Non-toxic and completely safe. The Agion antimicrobial compound is EPA and NSF approved and FDA listed for use in medical and food preparation equipment.
- Applications: Anywhere there is need for a clean environment (hospitals, laboratories, schools, medical centers, daycare, food processing etc.)

### On the Cover

11G05 x OL x 26D Entrance Lock

# Features, Benefits and Applications

## 11 Line Bored Lock

**SARGENT**  
**ASSA ABLOY**

The SARGENT 11 Line sets a higher standard for Grade 1 bored-in locks. The unique, T-Zone construction provides unequalled strength and durability for the most demanding applications such as schools and hospitals. This is accomplished by true interlocking between the lockbody and the latchbolt.

Specify the SARGENT 11 Line when you need the ultimate in strength and durability in a bored-in lock. Accept no substitute. There is no equal!

Patent pending and/or patent [www.assaabloydss.com/patents](http://www.assaabloydss.com/patents)



### T-Zone Construction — There is no equal!

Direct linkage with fixed alignment between the hub and the latchbolt is the best construction for quietly and effectively operating the latchbolt. For this reason, SARGENT has developed the interlocking aligning and latch tubes, which form a rugged torque resistant “T” in the critical twist area. This “T-Zone” construction, combined with long lasting components, makes 11 Line bored locks outstanding!

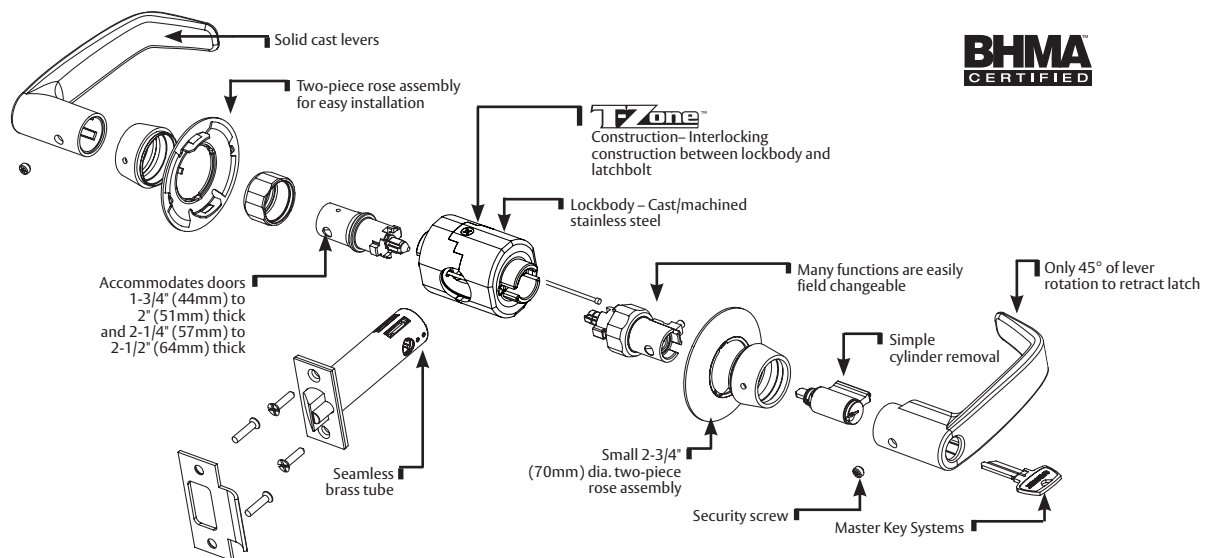

### Maximum Strength & Durability

- True interlocking between the cast/ machined stainless steel lockbody and latchbolt. Provides unequalled strength and durability
- Independent Testing proves:
  - Exceeds 15 TIMES ANSI/ BHMA A156.2 Grade 1 standard for cycle testing. Over 15,000,000 MILLION cycles!
  - Withstands 3 TIMES ANSI/ BHMA A156.2 Grade 1 torque force on a locked lever. Over 3000 in/lbs!
  - Virtually no lever sag ever
- In a class of its own! This lock raises the bar and sets new standards!
- 10 Year limited warranty. No service required to maintain warranty



### Maximum Convenience

- Two-piece rose assembly goes quickly into place
- “Out of the box and onto the door” packaging organizes the parts, has simple instructions and even a small tool kit
- Fits any 161 prep; Does not fit 160 door prep
- Two piece rose & collar for easier installation
- Only 45° of lever rotation required to retract latchbolt
- 18 functions. Many functions are easily field changeable
- 4 ADA lever designs and 4 roses available to cover a wide variety of door preps and design requirements
- Simple cylinder removal. Easy change outs
- 12 Architectural grade finishes
- SARGENT uses engineered solutions and flexible manufacturing processes to accommodate special applications

### Security

- The only bored lock on the market available with security lever catch feature for high vandalism application
- Resists vandalism
- Torx® and spanner screws
- Classroom security function available
- Security key systems available (Degree®, Signature, Keso F1, XC)

### Applications

- High traffic areas – offices, public buildings, hospitals
- High abuse areas – institutions, schools, retail
- Anywhere that requires the contemporary look of a small rose and durability that exceeds Grade 1 standards

### Innovation

- Patented “11 Line” construction with true interlocking between the lockbody and the latchbolt Provides unequalled strength and durability for the most demanding applications
- Revolutionary MicroShield® available, technology, containing the Agion™ antimicrobial compound, that suppresses the growth of destructive bacteria



Experience a safer  
and more open world

1-800-727-5477 • [www.sargentlock.com](http://www.sargentlock.com)

3

Copyright © 2007-2020, SARGENT Manufacturing Company. All rights reserved. Reproduction in whole or in part without the express written permission of SARGENT Manufacturing Company is prohibited. Patent pending and/or patent [www.assaabloydss.com/patents](http://www.assaabloydss.com/patents).

03/20 90640

### Windstorm Certifications: Florida Building Codes & UL Listings

SARGENT's products meet building codes that require hurricane, windstorm and FEMA certifications, including some of the most stringent building codes as specified in the Florida Building Code, Miami Dade Code and the International Building Code. Listed below are certifications and standards met by the 11 Line lock.

#### Florida Building Code: FL2998

#### UL Certification Directory: ZHEM.R21744 – Latching Hardware

ANSI/SDI-BHMA A250.13	"Testing and Rating of Severe Windstorm Resistant Components for Swinging Door Assemblies"
ANSI/ASTM E330	"Standard Test Method for Structural Performance of Exterior Windows, Doors, Skylights and Curtain Walls by Uniform Static Air Pressure Difference"
ANSI/ASTM E1886	"Standard Test Method for Performance of Exterior Windows, Curtain Walls, Doors, and Impact Protective Systems Impacted by Missile(s) and Exposed to Cyclic Pressure Differentials"
ASTM E1996	"Standard Specification for Performance of Exterior Windows, Curtain Walls, Doors and Impact Protective Systems Impacted by Windborne Debris in Hurricanes"
(TAS) 201	"Impact Test Procedures"*
(TAS) 202	"Standard Test Method for Structural Performance of Exterior Windows, Doors, Skylights and Curtain Walls by Uniform Static Air Pressure Difference"
(TAS) 203	"Criteria for Testing Products Subject to Cyclic Wind Pressure Loading"*

\* Published in the "Florida Building Code"

#### UL Certification Directory: ZHLL.R21744 – Products for Use in Windstorm-rated Assemblies

Certifications to meet assembly requirements are done in conjunction with doors from ASSA ABLOY Group companies CECO DOOR and CURRIES.

ASTM E330	"Standard Test Method for Structural Performance of Exterior Windows, Doors, Skylights and Curtain Walls by Uniform Static Air Pressure Difference"
ANSI/ASTM E1886	"Standard Test Method for Performance of Exterior Windows, Curtain Walls, Doors, and Impact Protective Systems Impacted by Missile(s) and Exposed to Cyclic Pressure Differentials"
ASTM E1996	"Standard Specification for Performance of Exterior Windows, Curtain Walls, Doors and Impact Protective Systems Impacted by Windborne Debris in Hurricanes"
AAMA/WDMA/CSA 101/1.S.2/A440	"Standard/Specification for Windows, Doors, and Unit Skylights"
FEMA Publication 320	"Taking Shelter From the Storm: Building a Safe Room for Your Home or Small Business", investigated with respect to impact and pressure requirements only.
FEMA Publication 361	"Design and Construction Guidance for Community Safe Rooms", investigated with respect to impact and pressure requirements only
ICC 500	"ICC/NSSA Standard for the Design and Construction of Storm Shelters", investigated with respect to impact and pressure testing. Minimum missile impact speeds vary with the design wind speed desired for a particular product. The information below correlates design wind speed to the minimum missile speeds as discussed in Table 305.1.1 of ICC 500

# STC55 Acoustic Door System

## 11 Line Bored Lock

**SARGENT**  
**ASSA ABLOY**

---

### STC55 Acoustical Door Systems from Security Metal Products

SARGENT 11 Line bored locks are part of the STC Acoustical Door Systems from ASSA ABLOY Group brand Security Metal Products (SMP). The STC55 Acoustical Door Systems are the perfect choice for any room where sound transmission needs to be kept to a minimum. This solution encompasses door, frame, sound seals and threshold and lock. All door systems use standard locks. The STC55 requires a special version of the 11 Line lock.

To order the 11 Line bored lock for use with the STC55 door system, include the STC55 option in the 11 Line order string and specify the B or O rose only. With this option, it will be configured for use with the Acoustical Door System.

To learn more about SMP and the STC Acoustical Door Systems, please visit [www.secmet.com](http://www.secmet.com) and search "sound / acoustical" products.

---

### Applications

- Theatres and auditoriums
- Sound stages and production areas
- Recording studios
- Music classrooms
- Conference rooms
- Convention halls
- Offices and more

# Functions

## 11 Line Bored Lock

### Single Cylinder Functions

#### 04 Storeroom or Closet

11G04

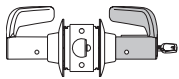

- Deadlocking latch
- Latchbolt by lever inside or key outside
- Outside lever rigid at all times
- **ANSI F86**

#### 05 Entrance or Office

11G05

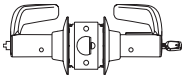

- Deadlocking latch
- Latchbolt by either lever unless outside lever is locked by turn button in inside lever
- Turn button must be released manually
- Key only retracts latchbolt when outside lever is locked
- **ANSI F81**

#### 24 Entrance or Office

11G24

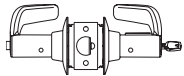

- Deadlocking latch
- Latchbolt by either lever unless outside lever is locked by push button in inside lever
- Push button released by key or turning inside lever
- Closing door does not unlock outside lever or release button
- **ANSI F82**

#### 37 Classroom

11G37

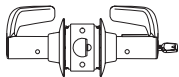

- Deadlocking latch
- Latchbolt by either lever unless outside lever is locked by key
- Key in outside lever locks or unlocks outside lever
- Inside lever always operative
- **ANSI F84**

#### 44 Service Station

11G44

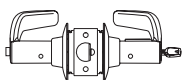

- Deadlocking latch
- Latchbolt by either lever unless outside lever is locked by push button of inside lever
- Key retracts latchbolt when outside lever is locked
- Push button will not depress unless door is in closed position
- Push button released by turning inside lever or by key in outside lever unless push button is fixed in locked position by turning coin slot in inside lever
- **ANSI F92**

#### 50 Hotel, Dormitory or Apartment

11G50

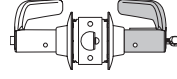

- Deadlocking latch
- Latchbolt by key outside and lever inside
- Outside lever always rigid
- Depressing push button when door is closed shuts out all keys except emergency key and projects visual occupancy indicator in cylinder face
- Push button will not depress unless door is closed in position
- Push button released by turning inside lever automatically reactivating all keys and retracting visual occupancy indicator
- Lock out key fixes push button in locked position, shutting out all keys except emergency
- Lock out key must be ordered separately (10-0042).
- See option page for restrictions to 50 function
- **ANSI F93**

#### 54 Corridor

11G54

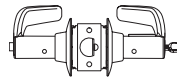

- Deadlocking latch
- Latchbolt by either lever unless outside lever is locked by push button inside or key outside
- Rotating inside lever releases button
- Push button will not depress unless door is in closed position
- Key outside locks or unlocks outside lever and releases inside button
- **ANSI F90**

#### Hand

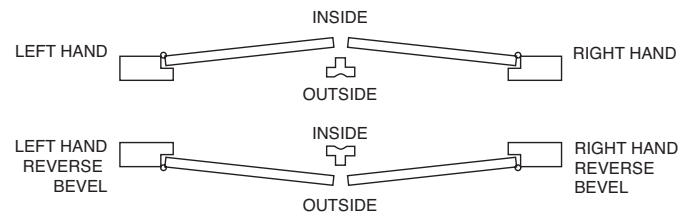

Shaded lever indicates it is rigid at all times.

### Double Cylinder Functions

#### 16 Classroom, Security, Apartment, Exit, Privacy

11G16

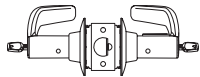

- Deadlocking latch
- Latchbolt by either lever unless outside lever is locked by key in inside lever
- Key in outside lever only retracts latchbolt when outside lever is locked
- **ANSI F88**

#### 17 Utility, Asylum or Institutional

11G17

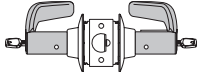

- Deadlocking latch
- Both levers rigid at all times
- Latchbolt by key either side
- Use only on rooms with more than one exit
- **ANSI F87**

#### 30 Communicating

11G30

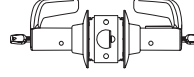

- Deadlocking latch
- Latchbolt by either lever
- Key in either lever locks or unlocks its own lever only
- Use only on rooms with more than one exit
- **ANSI F80**

#### 38 Classroom Security Intruder

11G38

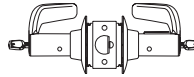

- Deadlocking latch
- Latchbolt by either lever unless outside lever is locked by key
- Key in either lever locks or unlocks outside lever
- When inside key locks the outside lever only the inside key can unlock the outside lever. The outside key only retracts the latchbolt until outside lever is unlocked by inside key
- Inside lever always operable
- Locking direction indicated on inside rose standard with this function. Available on rose designs E, L and O

### Non-Cylinder Functions

#### 13 Exit

11G13

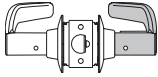

- Deadlocking latch
- Latchbolt by inside lever
- Outside lever rigid at all times
- **ANSI F89**

#### 15 Passage

11U15

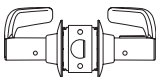

- Latchbolt by either lever
- **ANSI F75**

#### 15-3 Exit or Communicating

11G15-3

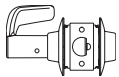

- Deadlocking latch
- Blank rose outside
- Latchbolt by lever inside
- Minimum clearance of 1-1/4" (32mm) required between doors

#### 65 Privacy/Bathroom

11U65

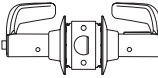

- Latchbolt by either lever unless outside lever is locked by push button in inside lever
- Turning inside lever or closing door releases button
- Emergency button in outside lever unlocks, with use of a blade screw driver in outside lever and releases inside button
- **ANSI F76A**

#### 68 Hospital Privacy

11U68

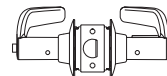

- Latch by either lever unless outside lever is locked by push button in inside lever
- Turning inside lever or closing door releases button
- Rotating thumbturn in outside lever unlocks the outside lever and releases the inside button
- Not available in the "J" lever design

#### 93 Single Lever Pull

11U93

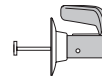

- For wood or custom hollow metal doors
- Lever and rose attached by through-bolt and four surface applied screws (hidden)
- Requires 5/16" (8mm) diameter hole

#### 94 Double Lever Pull

11U94

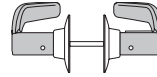

- For wood or custom hollow metal doors
- Lever and rose both sides joined by one through-bolt and four surface applied screws each side (hidden)
- Requires special door preparation – see template

#### 94-2 Double Lever Pull

11U94-2

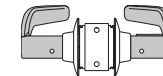

- For 161 and ANSI A115.2 prepared doors
- Lever and rose both sides joined by aligning tube and latchbolt tube
- Dummy latch plate



Shaded lever indicates it is rigid at all times.

# Function Conversion Chart and Retrofit Options

**SARGENT**  
**ASSA ABLOY**

## 11 Line Bored Lock

### 11 LINE FUNCTION CONVERSION CHART

FUNCTION	INSIDE LEVER	INSIDE COLLAR	INSIDE SLEEVE	LATCH	BEARING	OUTSIDE SLEEVE	OUTSIDE COLLAR	OUTSIDE LEVER
04: Storeroom/Closet	Passage lever	11-0031	11-2151	11-2106(B)	11-2899	11-2009	(On sleeve)	Cylinder lever
05: Entrance/Office	Pushbutton lever	11-0031	11-2152	11-2106(B)	11-2899	11-2009	(On sleeve)	Cylinder lever
13: Exit	Passage lever	11-0031	11-2151	11-2106(B)	11-2899	11-2010	(On sleeve)	Passage lever
15: Passage	Passage lever	11-0031	11-2153	11-2107(A)	11-2899	11-2153	11-0031	Passage lever
15-3: Exit or Communicating	Passage lever	11-0031	11-2153	11-2106(B)	11-2899	None - See Parts Book	None - See Parts Book	None - See Parts Book
16: Classroom Security/ Apartment	Cylinder lever	(On sleeve)	11-2011	11-2106(B)	11-2899	11-2009	(On sleeve)	Cylinder lever
17: Utility/Asylum	Cylinder lever	(On sleeve)	11-2013	11-2106(B)	11-2899	11-2012	(On sleeve)	Cylinder lever
24: Entry	Pushbutton lever	11-0031	11-2157	11-2108(K)	11-2899	11-2909	(On sleeve)	Cylinder lever
30: Communicating	Cylinder lever	(On sleeve)	11-2014	11-2106(B)	11-2899	11-2015	(On sleeve)	Cylinder lever
37: Classroom	Passage lever	11-0031	11-2153	11-2106(B)	11-2899	11-2014	(On sleeve)	Cylinder lever
38: Classroom Security	Cylinder lever	(On sleeve)	11-2011	11-2106(B)	11-2899	11-2017	(On sleeve)	Cylinder lever
44: Service Station	Pushbutton lever	11-0031	11-2154	11-2110(D)	11-2899	11-2009	(On sleeve)	Cylinder lever
50: Hotel/Motel	Pushbutton lever	11-0031	11-2155	11-2110(D)	11-2899	11-2016	(On sleeve)	Cylinder lever
54: Dormitory	Pushbutton lever	11-0031	11-2156	11-2110(D)	11-2899	11-2017	(On sleeve)	Cylinder lever
65: Privacy/Bathroom	Pushbutton lever	11-0031	11-2156	11-2111(C)	11-2899	11-2055	(On sleeve)	Cylinder lever

**Note:** Functions 93, 94 and 94-2 are of different construction. See Parts Pages for parts and construction

### SARGENT 6010 Replacement Kit — for 7600 Integra Lock

### Large Rose and Cover Plate



Sub Front



800 Strike



808 Strike



"L" Rose  
3-1/2" (89mm) diameter  
Order: 11-2446 x finish



Cover Plate  
3" x 12" (76mm x 305mm)  
Order: 06-0037 x finish  
(2 qty. required)

Screws  
Order: 01-2037 x finish  
(8 qty. required)

- For installation of standard backset 11 Line lock replacing old 7600 Integra locks in wood doors
- Finishes: 03, 04, 10, 10B, 10BE, 10BL, 15, 20D, 26, 26D, BSP and WSP
- Replacement Kit consist of:

Quantity	Item	Item Number	Size
1	Sub Front	08-0562 x finish (108mm x 32mm)	4-1/4" x 1-1/4"
1	Strike (must specify 800 or 808)	800 x finish (with screws) 808 x finish (with screws)	2-3/4" x 1-1/4" x 1-1/4" (70mm x 32mm x 32mm) 4-7/8" x 1-1/8" x 1-1/4" (121mm x 29mm x 32mm)
1	Strike Box	08-0055 77-1141	For 800 Strike For 808 Strike (ANSI)
2	Sub Front Screws	01-5001	#10-24 x 3/4" (19mm)

**Note:** Strikes will not retrofit for strikes 4-1/4" x 1-1/8" x 1-1/4" (108mm x 29mm x 32mm).  
Lock will not retrofit for lock front plate size 5-1/4" x 1-1/4" (133mm x 32mm) – 36-7600 locks

- To cover existing holes on face of door
- "L" roses can be ordered with the 11 Line lock  
Example: 11G05 x LB x 26D
- Cover plate, if required, must be ordered separately

Copyright © 2007-2020, SARGENT Manufacturing Company. All rights reserved. Reproduction in whole or in part without the express written permission of SARGENT Manufacturing Company is prohibited. Patent pending and/or patent www.assaabloydss.com/patents.

90640 03/20



# Lever and Rose Designs

## 11 Line Bored Lock

### Lever & Rose Designs

#### OL Design

- Rose: O - Wrought
- Lever: L - Cast

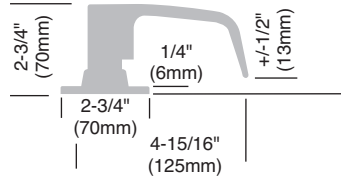

**Note:** Any rose and lever on this page can be combined to suit individual taste

#### LJ Design

- Rose: L - Wrought
- Lever: J - Cast

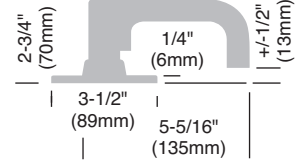

**Note:** Lever projections shown are for 1-3/4" (44mm) doors and will vary by door thickness

#### EB Design

- Rose: E - Wrought
- Lever: B - Cast

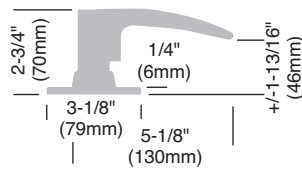
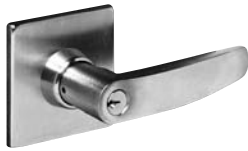

#### BP Design

- Rose: B - Wrought
- Lever: P - Cast

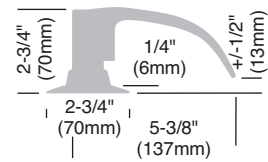

### Type 161 Cutout

If weather-stripping, acoustical materials or silencers are used on the door or frame, care must be taken in the installation so that it will not interfere with the ease in which the latchbolt enters the strike

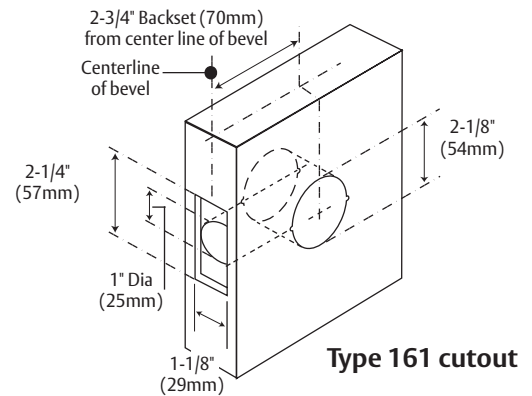

# Latches and Strikes

## 11 Line Bored Lock

### Latch Assemblies

Part	Code	Functions
<b>Standard 2-3/4" (70 mm) Backset</b>		
11-2106	B	04, 05, 13, 15-3, 16, 17, 30, 37, 38
11-2107	A	15
11-2108	K	24
11-2110	D	44, 50, 54
11-2111	C	65, 68
<b>23- option 3-3/4" (95mm) Backset</b>		
11-2113	B	04, 05, 13, 15-3, 16, 17, 30, 37, 38
11-2114	A	15
11-2115	K	24
11-2117	D	44, 50, 54
11-2118	C	65, 68
<b>25- option 5" (127mm) Backset</b>		
11-2120	B	04, 05, 13, 15-3, 16, 17, 30, 37, 38
11-2121	A	15
11-2122	K	24
11-2124	D	44, 50, 54
11-2125	C	65, 68
<b>41-option 3/4" (19mm) Throw</b>		
08-2517	—	04, 05, 15, 15-3, 16, 37

**Note:** Code letter stamped on inside corner of latch front identifies function(s) compatible with the latch assembly

### 23- or 25- Option: Extended Backsets

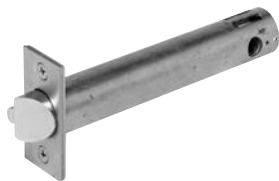

- 11 Line latches are available with extended backsets:  
23- option 3-3/4" (95mm)  
25- option 5" (127mm)
- To order with lock, specify 23- or 25- option and backset at end of order  
Example: 23-11G05 x OL x 10B x 3-3/4" (95mm) backset
- To order latch separately, specify: Part number x finish (see table above)
- Finishes: 03, 04, 09, 10, 10B, 10BE, 15, 20D, 26, 26D, BSP, WSP

### 41- Option: 3/4" (19mm) Throw for Pairs of Doors



- For use on pairs of doors
- Guarded latchbolts listed by Underwriters Laboratories for use on 3-hour A Label pairs of doors
- Available functions: 11G04, 11G05, 11G13, 11G15, 11G15-3, 11G16, 11G17, 11G30, 11G37 and 11G38
- To order with lock, specify 41- option  
Example: 41-11G05 x OB x 10B
- 2-3/4" (70mm) Backset only
- Requires 78° of lever rotation to retract latchbolt
- Please note: special door prep required for 41- option — refer to template
- Finishes: 03, 04, 09, 10, 10B, 10BE, 15, 20D, 26, 26D, BSP, WSP

### 2-3/4" Curved Lip 800 T-Strike (Standard)

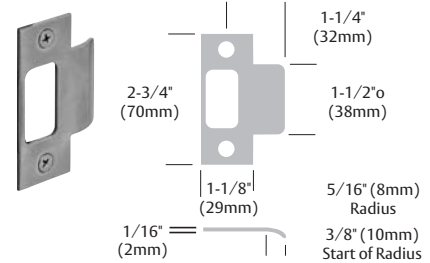

- Brass, bronze or stainless steel
- Furnished standard with 1-1/4" (32mm) curved lip, measured from center of strike screw holes to end of lip
- Lip lengths: 1-1/8" (29mm) to 2-7/8" (73mm) in 1/4" (6mm) increments only
- To order 800 strike with lock, specify lock and lip length  
Example: 11G05 x LL x 10B x 1-3/4" (44mm) lip
- To order strike separately, specify 800 strike x finish x lip length
- Wrought box strike, 08-0055, provided standard
- Finishes: 03, 04, 09, 10, 10B, 10BE, 14, 15, 20D, 32, 32D, BSP, WSP

### 28- Option: 4-7/8" Curved Lip 808 ANSI Strike

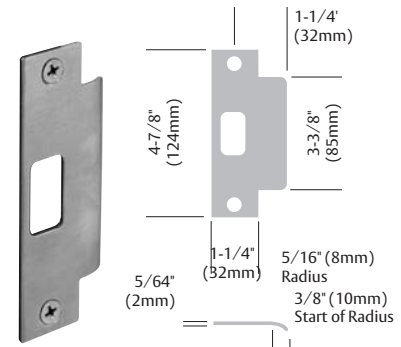

- Brass, bronze or stainless steel
- Conforms to ANSI standard 115.2
- Furnished standard with 1-1/4" (32mm) curved lip, measured from center of strike screw holes to end of lip
- Lip lengths: 1-1/8" (29mm), 1-1/4" (32mm) and 1-3/8" (35mm) to 2-7/8" (73mm) in 1/4" (6mm) increments only
- To order 808 strike with lock, specify 28- option with lock and lip length  
Example: 28-11G05 x LL x 10B x 1-3/4" (44mm) lip
- To order strike separately, specify 808 strike x finish x lip length
- Wrought box strike not provided, order separately as 77-1141
- Finishes: 03, 04, 09, 10, 10B, 10BE, 15, 20D, 32, 32D, BSP, WSP

### Cylinders

- Finishes: 04, 15

Type	Pins	Standard Cylinder	Hotel Cylinder	Interchangeable Core <sup>^</sup>	
				Large Format	Small Format
Conventional	6	C11-1	C11-2	6300	7300B
	7	N/A	N/A	N/A	7P-7300B
Signature	6	10-C11-1	N/A	10-6300	N/A
XC	6	11-C11-1	N/A	11-6300	N/A
	7	N/A	N/A	N/A	11-7P-7300B
Degree® DG1	6	DG1-C11-1	DG1-C11-2	DG1-6300	N/A
Degree® DG2	6	DG2-C11-1	N/A	DG2-6300	N/A
Degree® DG3	6	DG3-C11-1	N/A	DG3-6300	N/A

All cylinders are supplied with 2 nickel silver change keys.  
When cylinders are ordered keyed to 5 pin systems, the (6th) last chamber will be empty.

Cylinders are supplied random keyed unless specified 1 bitted or master keyed. For master keyed orders provide keying details as requested on SARGENT Keyed Order Lead Sheets, located in the price book or contact customer service.

To order cylinders separately, specify part number x keyway x finish (i.e. C11-1 x LA x 15)

<sup>^</sup> Locks will be provided with the applicable tailpiece per the type interchangeable and/or removable core being used.

For example standard cores and Degree® cores require different tailpieces. When ordering complete locks, the appropriate option code must be specified in accordance to the permanent core being used. See pages 13-14 for cylinder options.



**C11-1**



**6300**



**7P-7300B**

### Cylinders with Competitive Keyways

Competitive Keyway	Part Number
Schlage® C	SC-C11-1
Schlage® E	SE-C11-1

All cylinders are 6-pin, 0-bitted and supplied with two brass key blanks. Cylinders include tail piece.

Refer to Cylinders and Components catalog for more information.

### Interchangeable Core Tailpieces (replacement parts)

Used with:	Type	P/N
6300	LFIC Conventional	11-0172
10-6300	LFIC Signature	
11-6300	LFIC XC	11-5003
DGX-6300	LFIC Degree®	
7300B	SFIC	11-0171
7P-7300B	SFIC 7 Pin	11-0172
11-7P-7300B	SFIC XC	11-0276

Note: Tailpieces included with lock.

### Levers That Accept Cylinders/Cores from Other Manufacturers\*

Cylinder Type	Option Code Ordered with Lock	Available Levers	Tailpiece P/N (provided with lock)	Competitor Cylinder Compatibility
<b>Fixed Core</b>				
Schlage® 6-pin	30-	All	11-2578	Schlage® Conventional or Primus®
Yale® 6-pin	YC-	L, P	11-5004 (spacer)	Yale® 1803-54L, 5803-54L and K403-54L cylinders only
Yale® 7-pin	YC-7P-	L, P		Yale® 1803A-54L, 5803A-54L and K403A-54L cylinders only
<b>Interchangeable Core</b>				
SFIC 6- or 7-pin	70-, 72-, 73-	All	11-0171 (6-pin)	All 6- or 7-pin small format interchangeable cores
			11-0172 (7-pin)	
Schlage® LFIC 6-pin	SF-	L	11-0403	All Schlage® 6-pin large format interchangeable cores
Yale® LFIC 6-pin	YRC-	L, P	11-5005 (tailpieces for both 6- and 7-pin included when ordered separately)	All Yale® 6-pin large format interchangeable cores
Yale® LFIC 7-pin	YRC-7P-	L, P		All Yale® 7-pin large format interchangeable cores

\*Cylinder/core not included.

Experience a safer  
and more open world

# Mechanical Options

## 11 Line Bored Lock

### Mechanical Options:

Backset Options	<b>23-</b>	3-3/4" backset x 2-1/4" x 1-1/8" front
	<b>25-</b>	5" backset x 2-1/4" x 1-1/8" front
Strike	<b>28-</b>	#808 strike; standard lip length 1-1/4". Other lip lengths must be specified; available lengths are 1-1/8", 1-3/8", 1-5/8", 1-7/8", 2-1/8", 2-3/8", 2-5/8" & 2-7/8"
Thick Doors	<b>31-</b>	For 2-1/4" to 2-1/2" thick doors, centered in door prep, no paneling. Consult factory for other door thicknesses available by special application.
Security Fasteners	<b>36-</b>	Six lobe security head screws
	<b>37-</b>	Spanner head screws
3/4" Throw	<b>41-</b>	3/4" (19mm) latch throw (04, 05, 13, 15, 15-3, 16, 17, 30, 37 and 38 functions only) 78° lever rotation required
Lead Lined	<b>74-</b>	Lead Lining I/S rose, O/S rose, and Latch Tube
Tactile Warning Options	<b>75-</b>	Tactile warning – handicap warning milled on backside of inside lever
	<b>76-</b>	Tactile warning – handicap warning milled on backside of outside lever
	<b>77-</b>	Tactile warning – handicap warning milled on backside of both levers
	<b>85-</b>	Tactile warning – abrasive coating on inside lever
	<b>86-</b>	Tactile warning – abrasive coating on outside lever
Finish Protection	<b>87-</b>	Tactile warning – abrasive coating on both levers
	<b>SG-</b>	MicroShield® antimicrobial clear powder coat (Only available with 15 and 26D finishes)
	<b>CPC-</b>	Clear Powder Coat over 26D – 11G05 x OL x 26D x CPC
Additional Security	<b>SL-</b>	High security lever attachment (patent pending) available for keyed functions
Acoustical Door Systems	<b>STC</b>	STC 55 acoustical door system (see page 5)
Box Strike	<b>WBS-</b>	Wrought Box Strike

Copyright © 2007-2020, SARGENT Manufacturing Company. All rights reserved. Reproduction in whole or in part without the express written permission of SARGENT Manufacturing Company is prohibited. Patent pending and/or patent www.assaabloydss.com/patents.

# Cylinder Options

## 11 Line Bored Lock

### Cylinder Options:

Conventional Cylinder	-	SARGENT conventional cylinders supplied standard (nomenclature not required)
Degree Key System	DG1-	SARGENT Degree key system level 1 (bump resistant with patented keys)
	DG1-21-*	Degree level 1 construction master keying
	DG1-60-	Degree level 1 removable disposable construction core
	DG1-63-	Degree level 1 removable core
	DG1-64-	Degree level 1 removable construction keyed LFIC
	DG1-65-*	Degree level 1 unassembled/uncombined fixed core component cylinder (packed loose for field keying)
	DG1-63-65-	Degree level 1 unassembled/uncombined removable core LFIC (packed loose for field keying)
	DG2-*	SARGENT degree key system level 2 (geographically exclusive; bump and pick resistant)
	DG2-21-*	Degree level 2 construction master keying
	DG2-60-*	Degree level 2 removable disposable construction core
	DG2-63-*	Degree level 2 removable core
	DG2-64-*	Degree level 2 removable construction keyed LFIC
	DG2-65-*	Degree level 2 unassembled/uncombined fixed core component cylinder (packed loose for field keying)
	DG2-63-65-*	Degree level 2 unassembled/uncombined removable core LFIC (packed loose for field keying)
	DG3-*	SARGENT Degree key system level 3 (geographically exclusive; UL437 certified; bump and pick resistant)
	DG3-21-*	Degree level 3 construction master keying
	DG3-60-*	Degree level 3 removable disposable construction core
DG3-63-*	Degree level 3 removable core	
DG3-64-*	Degree level 3 removable construction keyed lfic	
Signature Key System	10-*	SARGENT Signature key system
	10-21-*	SARGENT Signature construction key system (lost ball)
Signature Removable Core	10-63-*	SARGENT Signature removable core cylinder
XC- Key System	11-*	XC key system (not available with other key systems, unless specified)
	11-21-*	XC - construction key system (lost ball)
XC- Large Format Interchangeable Core (Removable Core)	11-60-*	Lock to accept XC-LFIC (removable core) and provided with disposable plastic core; XC-LFIC permanent core ordered separately
	11-63-*	Lock provided with XC-LFIC (removable core); Includes master keying, grand master keying
	11-64-*	Lock to accept XC-LFIC (removable core) and provided with keyed construction core; XC-LFIC permanent core ordered separately.
XC- Small Format Interchangeable Cores	11-70-7P-*	Lock to accept XC-SFIC (7-pin, removable core) and provided with disposable plastic core; XC-SFIC permanent core ordered separately
	11-72-7P-*	Lock to accept XC-SFIC (7-pin, removable core) and provided with keyed construction core; XC-SFIC permanent core ordered separately
	11-73-7P-*	Lock provided with XC-SFIC (7-pin, removable core); Includes master keying, grand master keying
	11-65-73-7P-*	Lock provided with uncombined SFIC (7-pin, removable core); Packed loose
Construction Key Systems	21-*	SARGENT lost ball construction keying for conventional, XC and Signature Series (n/a with 63- or 73-)
	22-*	SARGENT construction split key system for conventional cylinders (existing systems only) (n/a with 10-, 11-, 63- or 73-)
Large Format Interchangeable Core (Removable Core)	60-*	Lock to accept LFIC (removable core) and provided with disposable plastic core; LFIC permanent core ordered separately
	63-*	Lock provided with LFIC (removable core); Includes master keying, grand master keying
	64-*	Lock to accept LFIC (removable core) and provided with keyed construction core; LFIC permanent core ordered separately

**Note:** Cylinder Options continued on the following page

\* Options not available with 11G50

# Cylinder Options

## 11 Line Bored Lock



### Cylinder Options:

Small Format Interchangeable Cores	<b>70-*</b>	Lock to accept SFIC (6 or 7-pin, removable core) and provided with disposable plastic core; SFIC permanent core ordered separately
	<b>72-*</b>	Lock to accept SFIC (6 or 7-pin, removable core) and provided with keyed construction core; SFIC permanent core ordered separately
	<b>73-*</b>	Lock provided with SFIC (6-pin, removable core); Includes master keying, grand master keying
	<b>73-7P-*</b>	Lock provided with SFIC (7-pin, removable core); Includes master keying, grand master keying
	<b>65-73-*</b>	Lock provided with uncombined SFIC (6-pin, removable core); Packed loose
	<b>65-73-7P-*</b>	Lock provided with uncombined SFIC (7-pin, removable core); Packed loose
Keso & Keso F1	<b>80-*</b>	Lock to accept Keso and Keso F1 cylinders - no cylinders provided
	<b>82-*</b>	Lock provided with SARGENT Keso security cylinder
	<b>F1-82-*</b>	Lock provided with SARGENT Keso F1 security cylinder (patented)
Bump Resistant	<b>BR-</b>	Bump resistant cylinder (available with conventional & conventional XC cylinders only)
Less Cylinder	<b>LC-</b>	Lock supplied less cylinder
Schlage® Keyways	<b>SC-*</b>	Schlage® C keyway cylinder, 0 bitted
	<b>SE-*</b>	Schlage® E keyway cylinder, 0 bitted
Accepts Schlage® Cylinders	<b>30-*</b>	Lever to accept Schlage® fixed core cylinder - cylinder is not provided
	<b>SF-*</b>	L lever to accept Schlage® large format interchangeable core (supplied less core, tailpiece included)
ASSA V-10** (See note below)	<b>VC-</b>	Lock provided to accept ASSA v-10 interchangeable core cylinders. V-10 cylinders are available from ASSA, Inc @ 800-235-7482
Accepts Yale® Cylinders/Cores	<b>YC-</b>	L or P Lever to accept Yale® 6-pin fixed core cylinder - cylinder is not provided
	<b>YC-7P-</b>	L or P Lever to accept Yale® 7-pin fixed core cylinder - cylinder is not provided
	<b>YRC-</b>	L or P Lever to accept Yale® 6-pin large format interchangeable core (supplied less core, but with tailpiece needed)
	<b>YRC-7P-</b>	L or P Lever to accept Yale® 7-pin large format interchangeable core (supplied less core, but with tailpiece needed)

\* Options not available with 11G50

\*\* To use ASSA V-10 (VA & VS) cylinders with the 11 Line Lock, specify (LC-) less cylinder option and the lock will accept VA or VS cylinders. V-10 cylinders are available from ASSA, Inc. @ 800-235-7482

Note: 11 Line locks will be provided with the applicable tailpiece per the type interchangeable and/or removable core being used. For example standard cores and Degree® cores require different tailpieces. Appropriate option codes must be specified in accordance to the permanent core being used.

### 11-0138 Installation Wrench



### 14-0299 Lockout Key



- For hotel function only
- Order separately

### 01-4530 6 Lobe Security Tool (T-20)



- Two, 6 Lobe security lever set screws packed standard with each lock
- One T-20 tool packed per lock

### 6 Lobe and Spanner Bit Packs

82-3855	6 lobe bit pack 6 bits (Sizes – T8, T9, T10, T15, T20, T25, T27) Requires 9/32" driver
82-3856	Spanner bit pack 5 bits (Sizes – 6, 8, 10, 12, 14) Requires 1/4" driver

# How to Order, Finishes, Packaging

## 11 Line Bored Lock

### How to Order

5	11-28-	11G05	B	B	15	Door 3
<b>Quantity</b>	<b>Options*</b>	<b>Lock &amp; Function</b>	<b>Rose</b>	<b>Lever</b>	<b>Finish</b>	<b>Additional Information</b>
	Available Options Pg 12-14 (Note: 28- for 808 ANSI Strike)	Available Functions Pg 6-7	Available Roses O, E, L & B Pg 9	Available Levers B, J, L & P Pg 9	Available Finishes Pg 16	Such as Item, Heading Number, Door Number, Keyset

\* Multiple Options may be selected

**Note:** Lock must be centered within door; For locks not centered contact factory

**Note:** 800 & 808 strikes have a standard 1-1/4 Lip length; all other lengths must be specified; available lengths are 1-1/8", 1-3/8", 1-5/8", 1-7/8", 2-1/8", 2-3/8", 2-5/8" & 2-7/8"

### Finishes

SARGENT #	Description	ANSI/BHMA
03	Polished brass, clear coated	605
04	Satin brass, clear coated	606
09	Polished bronze, clear coated	611
10	Satin bronze, clear coated	612
10B	Oxidized bronze, oil rubbed	613
10BE	Dark oxidized satin bronze - Equivalent	613E
10BL	Oxidized satin, bronze, clear coated	613L
14	Polished nickel, clear coated	618
15	Satin nickel, clear coated	619
20D	Statuary dark bronze, clear coated	624
26	Polished chrome	625
26D	Satin chrome	626
BSP	Black Suede Powder Coat	—
WSP	White Suede Powder Coat	—
SG- Option	MicroShield® available on 15 & 26D finishes only	

Zinc levers are plated to match ANSI/BHMA finish.

Custom colors available, consult factory.

Split finishes:

- Specify outside finish first i.e. 11G05 x BB x 26D x 03 x RH
- Handing must be specified
- Strike and latch front will match the following:  
RH & LH = inside finish  
RHR & LHR = outside finish

### Packaging

28-11G05 x OL
4 lbs. 8 oz./box (2.1 kg)
10 boxes/case



## 11 Line Bored Lock

### Suggested Architectural Specifications

#### 2.0 Bored Locksets – 11 Line

- A. All bored lever locks shall be manufactured by SARGENT Manufacturing Co., New Haven, CT.
- B. Locksets shall be able to withstand 3000 inch pounds of torque applied to the locked lever without gaining access.
- C. Locksets shall be cycle tested per ANSI A156.2, 1996, to nine million cycles without any visible lever sag.
- D. Locks required for fire doors shall be listed by Underwriters Laboratories for ratings of A label (3 hours) and less, for doors up to 4'0" (1.2m) x 10'0" (3m) and pairs of doors 8'0" (2.4m) x 10'0" (3m) (with 41-option).
- E. Locksets shall be able to fit a standard 2-1/8" (55 mm) bore without the use of through-bolts. Standard rose size shall be 2-3/4" (70 mm) in diameter.
- F. Lockset levers shall be made of solid material with no plastic fillers.
- G. Latchbolt head shall be one piece stainless steel.
- H. Latchbolt assemblies shall be encased within the lockbody.
- I. Cylinders: SARGENT Signature Series 6-pin cylinders with patented key control.
- J. Locks shall have 2-3/4" (70 mm) backset, standard.
- K. Strikes: Provide wrought boxes and strikes with proper lip length to protect trim but not to project more than 1/8" beyond trim, frame or inactive leaf. Where required, provide open back strike to allow practical and secure operation.
- L. Locksets shall have a ten year limited warranty.

The ASSA ABLOY Group is the global leader in access solutions. Every day, we help billions of people experience a more open world.

ASSA ABLOY Opening Solutions leads the development within door openings and products for access solutions in homes, businesses and institutions. Our offering includes doors, frames, door and window hardware, locks, perimeter fencing, access control and service.



SARGENT Manufacturing Company  
100 Sargent Drive  
New Haven, CT 06511 USA  
800-727-5477  
[www.sargentlock.com](http://www.sargentlock.com)

Founded in the early 1800s, SARGENT® is a market leader in locksets, cylinders, door closers, exit devices, electro-mechanical products and access control systems for new construction, renovation, and replacement applications. The company's customer base includes commercial construction, institutional, and industrial markets.  
Copyright © 2007-2020, SARGENT Manufacturing Company. All rights reserved. Reproduction in whole or in part without the express written permission of SARGENT Manufacturing Company is prohibited. Patent pending and/or patent [www.assaabloydss.com/patents](http://www.assaabloydss.com/patents).